



DAL LAGO TTC S.R.L. - Via Piave, 16 - 36077 Altavilla Vic.na (VI) - Italy
Tel +39 0444 349030 - Fax +39 0444 348964 - www.dallago.it - info@dallago.it

SCHÜTTE SF26 - AF26

APPARECCHIATURE E PARTI DI RICAMBI

ATTACHMENTS AND SPARE PARTS

EINRICHTUNGEN UND ERSATZTEILE

S13/003
martelletto / toggle
C3220C-23Z



S9/002
campana / sleeve
C3210A-22Z

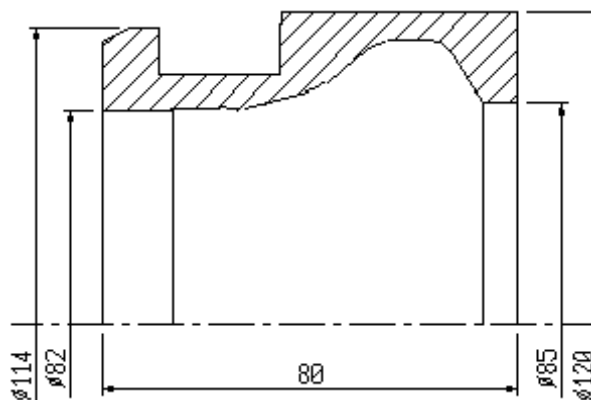

S13/005
martelletto / toggle
C3220B-23Z



S13/004
martelletto / toggle
C3220A-23Z



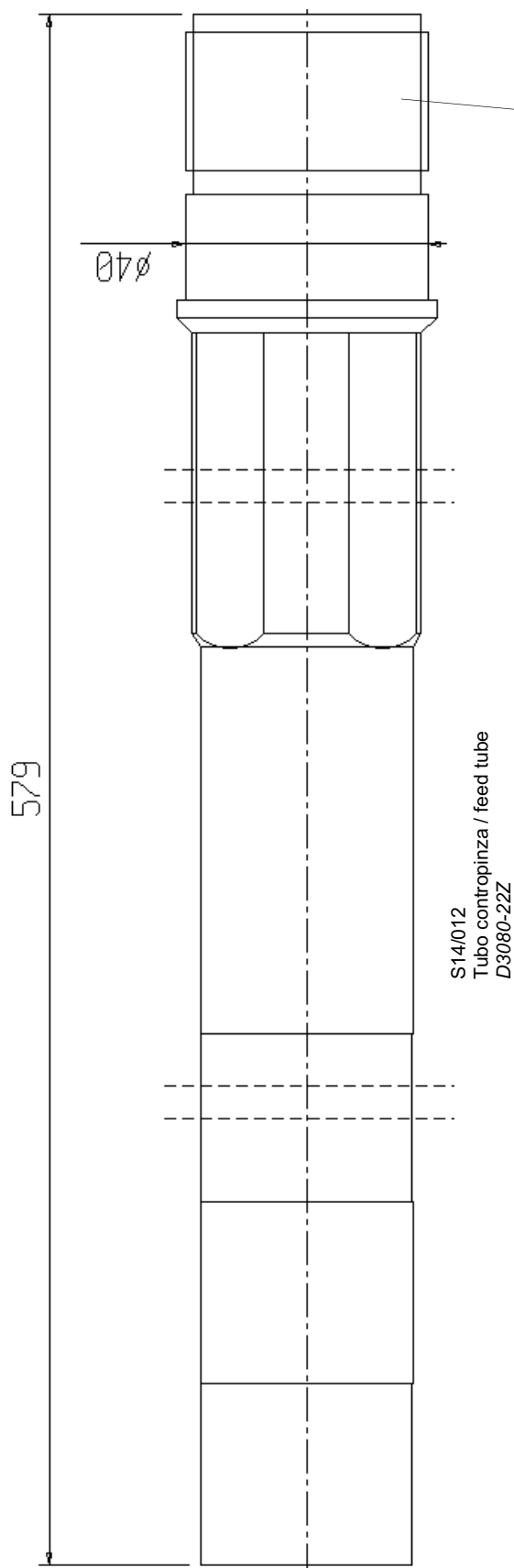

S15/040
ghiera / nut
D3063-23Z



S14/013
anello / ring
D3260A-22Z

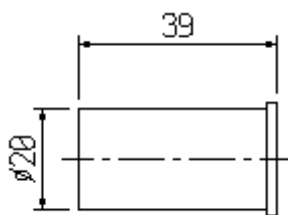

S5/036P Perno / Pin

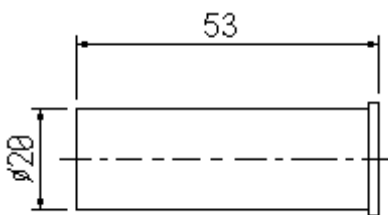

S8/033P Perno / Pin

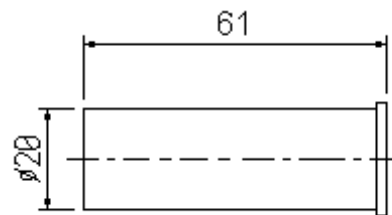

S8/031P Perno / Pin

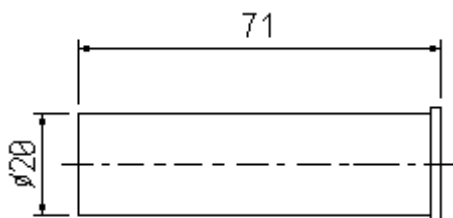

S8/035P Perno / Pin

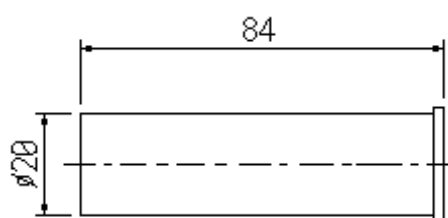

S8/030P Perno / Pin

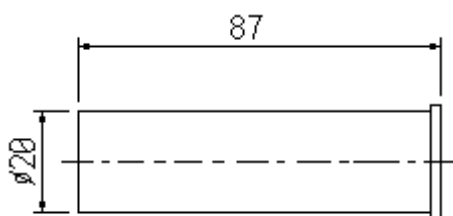

S8/034P Perno / Pin

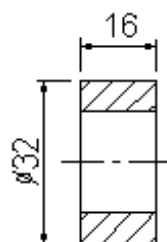

S8/031R Rullo / Roller

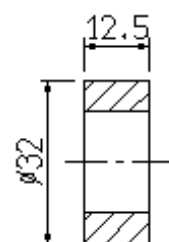

S5/036R Rullo / Roller

S8/036
Vite per camme / Cam screw
C5820A-44M
2.81.15.68.1

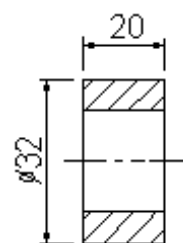

S8/030R Rullo / Roller

S8/060B
Distanziale camme / Cam spacer
C5830A-44M



S8/060
Distanziale camme / Cam spacer
C5830A-67M
2.24.28.35.1

