

APPLICAZIONE
TORNOS



Linea TORNOS DECO10

Assiale corto 15 mm

ATO.DE10.0115

Pinza	ER-11
Rapporto	1:1
Velocità	12000max
Trasmissione	puleggia
Lubrificazione	a vita

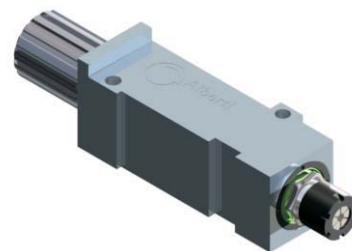

Assiale lungo 30

ATO.DE10.0130

Pinza	ER-11
Rapporto	1:1
Velocità	12000 max
Trasmissione	puleggia
Lubrificazione	a vita

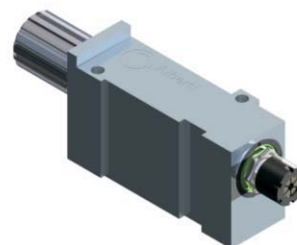

Assiale multiplo 3 uscite

ATO.DE10.1103

Pinza	ER-11
Rapporto	1:1
Velocità	12000 max
Trasmissione	puleggia
Lubrificazione	a vita



Assiale contro-operazione

ATO.DE10.0100

Pinza	ER-11
Rapporto	1:1
Velocità	12000max
Trasmissione	puleggia
Lubrificazione	a vita



Radiale contro-operazione

ATO.DE10.0210

Pinza	ER-11
Rapporto	1:1
Velocità	9000 max
Trasmissione	puleggia
Lubrificazione	a vita

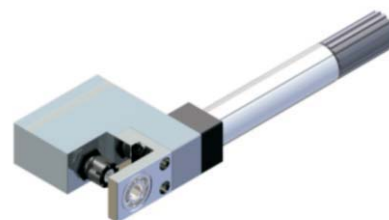



Linea TORNOS DECO10

Regolabile contro-op.

ATO.DE10.0310

Pinza	ER-11
Rapporto	1:1
Velocità	9000 max
Trasmissione	puleggia
Lubrificazione	a vita

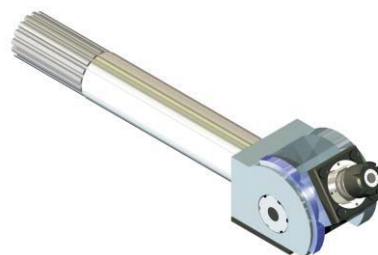

Assiale regolabile 0-90°

ATO.DE10.0300

Pinza	ER-11
Rapporto	1:1
Velocità	12000max
Trasmissione	puleggia
Lubrificazione	a vita

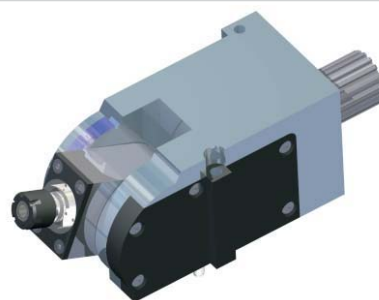

Radiale angolare 180°

ATO.DE10.0320

Pinza	ER-11
Rapporto	1:1
Velocità	12000 max
Trasmissione	puleggia
Lubrificazione	a vita

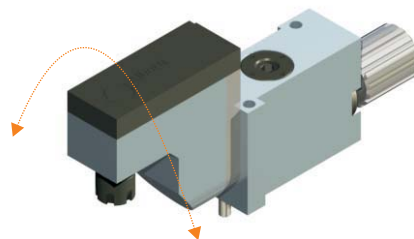

Radiale

ATO.DE10.0200

Pinza	ER-11
Rapporto	1:1
Velocità	12000 max
Trasmissione	puleggia
Lubrificazione	a vita

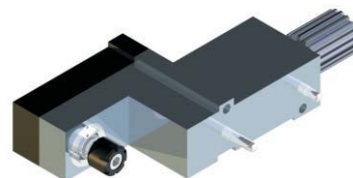

Radiale multiplo 3 uscite

ATO.DE10.2103

Pinza	ER-11
Rapporto	1:1
Velocità	12000 max
Trasmissione	puleggia
Lubrificazione	a vita

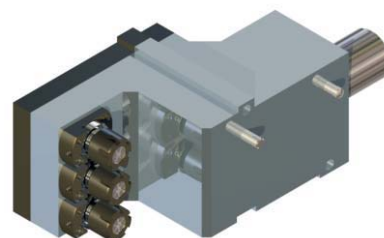



Linea TORNOS DECO10

Poligonatore

ATO.DE10.1000

Attrezzatura	Fresa per poligonatura
Rapporto	1:1
Velocità	8000 max
Trasmissione	puleggia
Lubrificazione	a vita

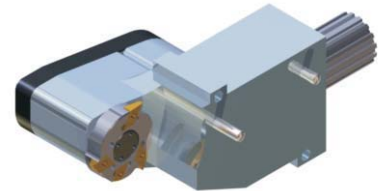

Turbionatore

ATO.DE10.0800

Attrezzatura	Testa per filettatura
Rapporto	1:1
Velocità	8000 max
Trasmissione	puleggia
Lubrificazione	a vita

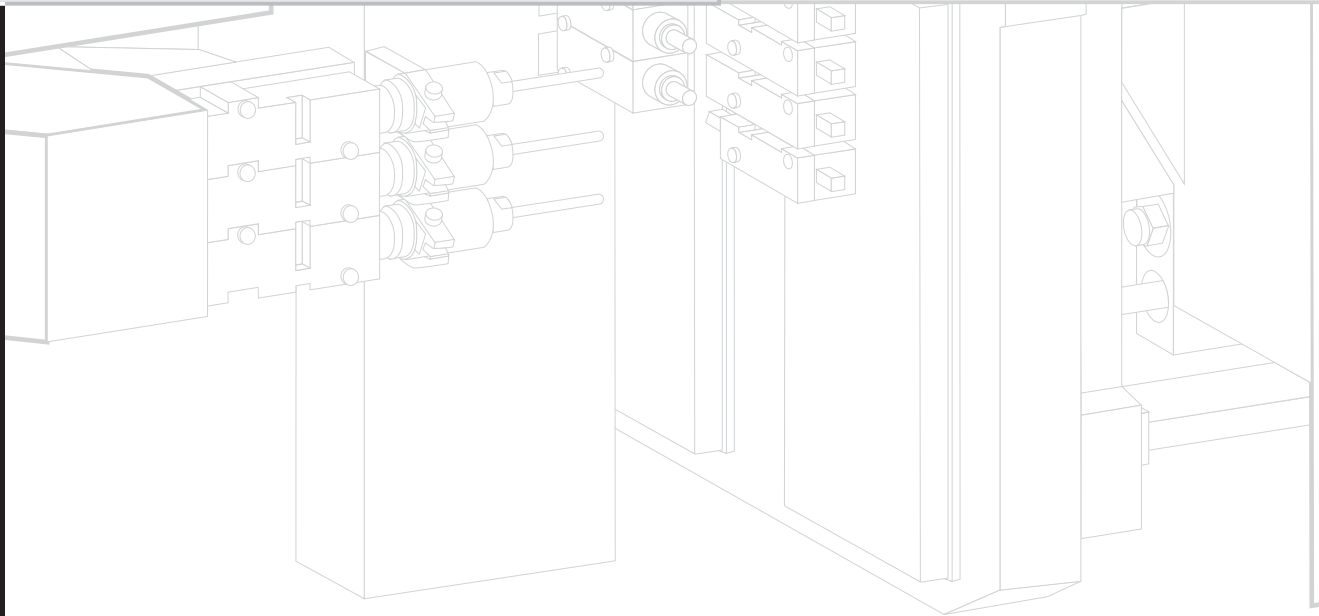
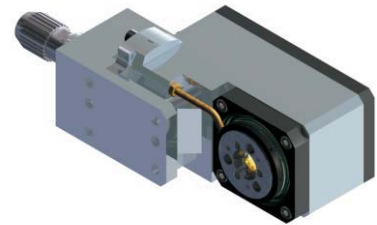



Linea TORNOS DECO13

Assiale corto

ATO.DE13.0100

Pinza	ER-16
Rapporto	1:1
Velocità	8000 max
Trasmissione	puleggia
Lubrificazione	a vita

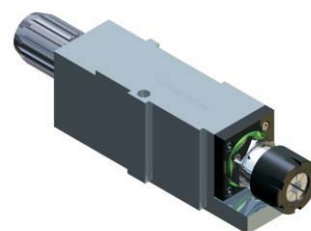

Assiale medio

ATO.DE13.0110

Pinza	ER-16
Rapporto	1:1
Velocità	8000 max
Trasmissione	puleggia
Lubrificazione	a vita



Assiale lungo

ATO.DE13.0120

Pinza	ER-16
Rapporto	1:1
Velocità	8000 max
Trasmissione	puleggia
Lubrificazione	a vita



Assiale multiplo 3 uscite

ATO.DE13.1103

Pinza	ER-11
Rapporto	1:1
Velocità	8000 max
Trasmissione	puleggia
Lubrificazione	a vita

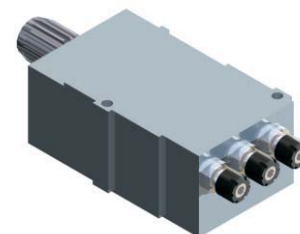

Radiale angolare 180°

ATO.DE13.0320

Pinza	ER-11
Rapporto	1:1
Velocità	8000 max
Trasmissione	puleggia
Lubrificazione	a vita

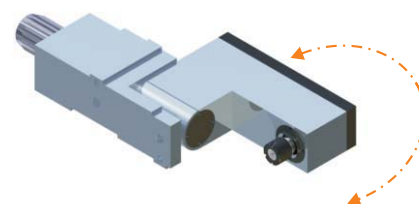



Linea TORNOS DECO13

Radiale

ATO.DE13.0200

Pinza	ER-11
Rapporto	1:1
Velocità	8000 max
Trasmissione	puleggia
Lubrificazione	a vita

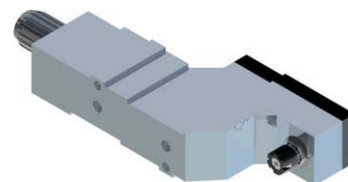

Radiale multiplo 3 uscite

ATO.DE13.2103

Pinza	ER-11
Rapporto	1:1
Velocità	8000 max
Trasmissione	puleggia
Lubrificazione	a vita

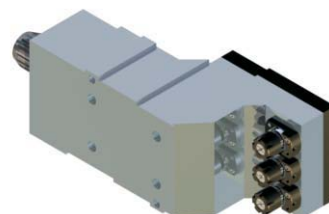

Assiale regolabile 0-90°

ATO.DE13.0300

Pinza	ER-11
Rapporto	1:1
Velocità	8000 max
Trasmissione	puleggia
Lubrificazione	a vita



Moltiplicatore

ATO.DE13.0500

Pinza	ER-16
Rapporto	1:3
Velocità	24000 max
Trasmissione	puleggia
Lubrificazione	a vita

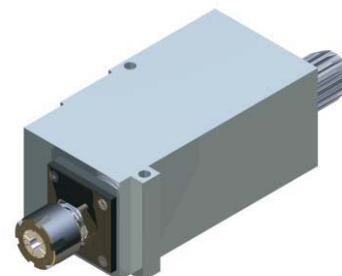

Riduttore

ATO.DE13.0600

Pinza	ER-16
Rapporto	3:1
Velocità	2000 max
Trasmissione	puleggia
Lubrificazione	a vita

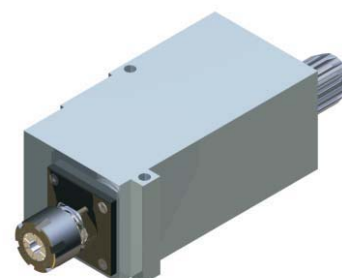



Linea TORNOS DECO13

Turbionatore

ATO.DE13.0800

Attacco	Testa per filettatura
Rapporto	1:1
Velocità	8000 max
Trasmissione	puleggia
Lubrificazione	a vita

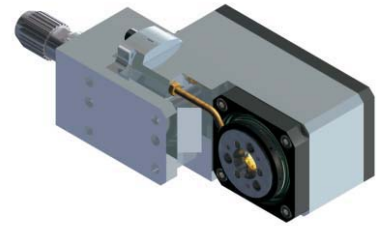

Poligonatore

ATO.DE13.1000

Fresa	Fresa per poligonatura
Rapporto	1:1
Velocità	8000 max
Trasmissione	puleggia
Lubrificazione	a vita

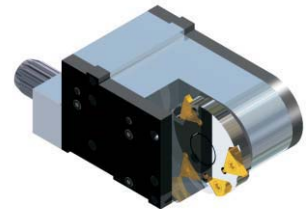

Portacreatore

ATO.DE13.0900

Attacco	Mandrino
Rapporto	1:1
Velocità	8000 max
Trasmissione	puleggia
Lubrificazione	a vita

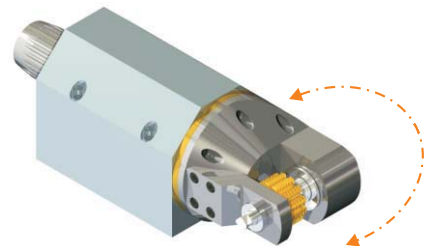



Linea TORNOS DECO20

Assiale corto

ATO.DE20.0100

Pinza	ER-25
Rapporto	1:1
Velocità	8000 max
Trasmissione	puleggia
Lubrificazione	a vita



Assiale medio

ATO.DE20.0110

Pinza	ER-25
Rapporto	1:1
Velocità	8000 max
Trasmissione	puleggia
Lubrificazione	a vita



Assiale lungo

ATO.DE20.0120

Pinza	ER-25
Rapporto	1:1
Velocità	8000 max
Trasmissione	puleggia
Lubrificazione	a vita



Assiale 3 uscite

ATO.DE20.1103

Pinza	ER-11
Rapporto	1:1
Velocità	8000 max
Trasmissione	puleggia
Lubrificazione	a vita

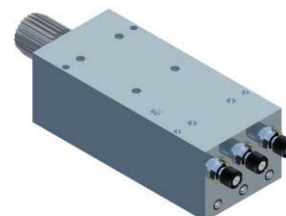

Radiale angolare 180°

ATO.DE20.0320

Pinza	ER-16
Rapporto	1:1
Velocità	8000 max
Trasmissione	puleggia
Lubrificazione	a vita

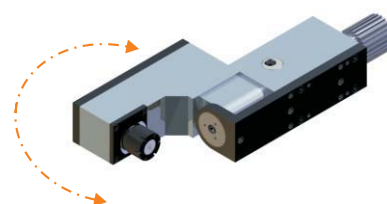



Linea TORNOS DECO20

Radiale

ATO.DE20.0200

Pinza	ER-11
Rapporto	1:1
Velocità	8000 max
Trasmissione	puleggia
Lubrificazione	a vita

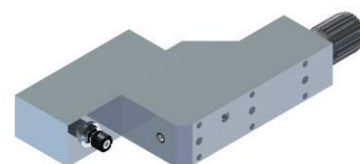

Radiale multiplo 3 uscite

ATO.DE20.2103

Pinza	ER-11
Rapporto	1:1
Velocità	8000 max
Trasmissione	puleggia
Lubrificazione	a vita

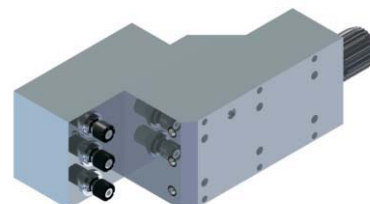

Assiale regolabile corto 0-90°

ATO.DE20.0300

Pinza	ER-11
Rapporto	1:1
Velocità	8000 max
Trasmissione	puleggia
Lubrificazione	a vita

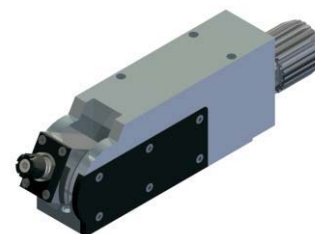

Assiale regolabile lungo 0-90°

ATO.DE20.0310

Pinza	ER-11
Rapporto	1:1
Velocità	8000 max
Trasmissione	puleggia
Lubrificazione	a vita

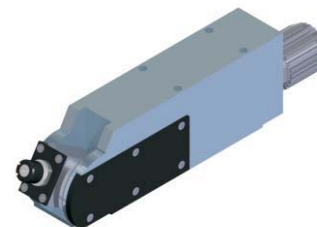

Portacreatore

ATO.DE20.0900

Attrezzatura	mandrino Ø13-16
Rapporto	4:1
Velocità	2000 max
Trasmissione	puleggia
Lubrificazione	a vita

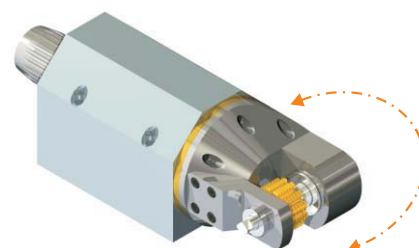



Linea TORNOS DECO20

Assiale moltiplicatore corto ATO.DE20.0500

Pinza	ER-25
Rapporto	1:4
Velocità	24'000 max
Trasmissione	puleggia
Lubrificazione	a vita



Assiale moltiplicatore lungo ATO.DE20.0510

Pinza	ER-25
Rapporto	1:4
Velocità	24'000 max
Trasmissione	puleggia
Lubrificazione	a vita



Assiale riduttore corto ATO.DE20.0600

Pinza	ER-25
Rapporto	4:1
Velocità	2000 max
Trasmissione	puleggia
Lubrificazione	a vita

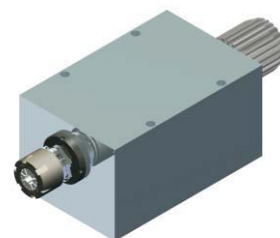

Assiale riduttore lungo ATO.DE20.0610

Pinza	ER-25
Rapporto	4:1
Velocità	2000 max
Trasmissione	puleggia
Lubrificazione	a vita



Sistema AM

Pinza	ER-20
Rapporto	1:1
Velocità	8000 max
Trasmissione	puleggia
Lubrificazione	a vita

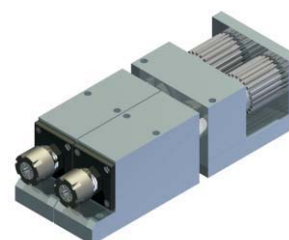



Linea TORNOS DECO20

Sistema AM

- Pinza
- Rapporto
- Velocità
- Trasmissione
- Lubrificazione

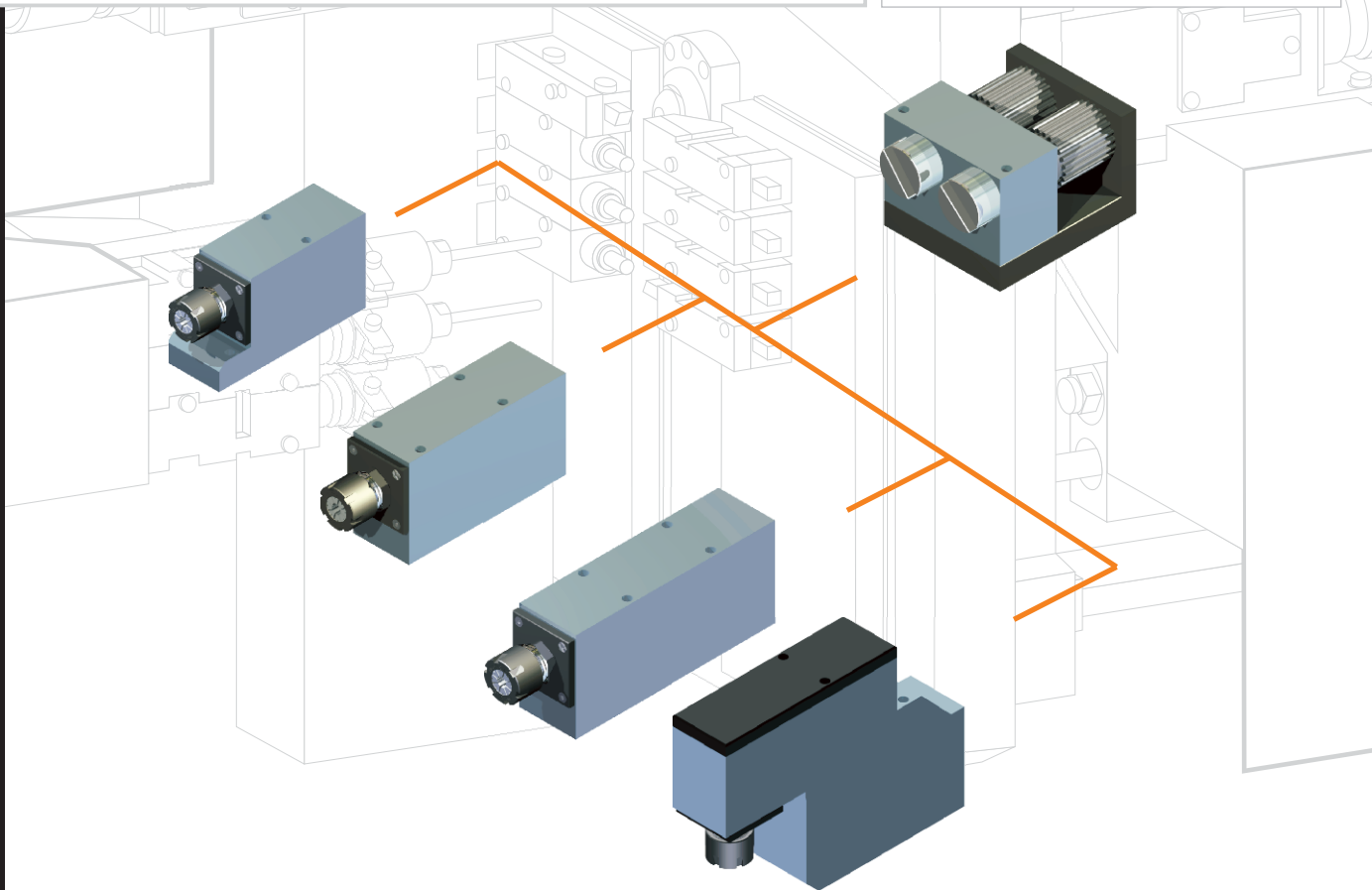
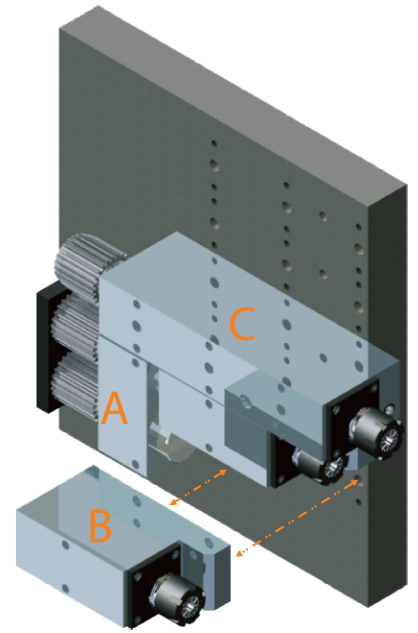
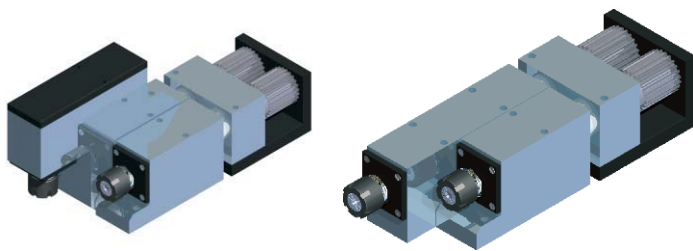



Linea TORNOS DECO20

Modulo AM

ATO.DE20.1200

Pinza	----
Rapporto	1:1
Velocità	8000 max
Trasmissione	puleggia
Lubrificazione	a vita

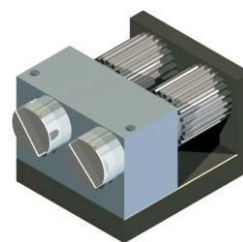

Assiale AM corto

ATO.DE20.1210

Pinza	ER-25
Rapporto	1:1
Velocità	8000 max
Trasmissione	puleggia
Lubrificazione	a vita

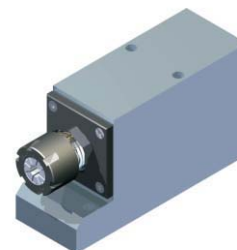

Assiale AM medio

ATO.DE20.1220

Pinza	ER-25
Rapporto	1:1
Velocità	8000 max
Trasmissione	puleggia
Lubrificazione	a vita

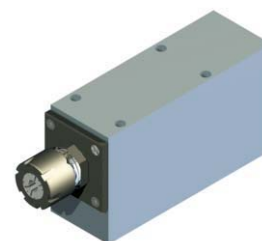

Assiale AM lungo

ATO.DE20.1230

Pinza	ER-25
Rapporto	1:1
Velocità	8000 max
Trasmissione	puleggia
Lubrificazione	a vita

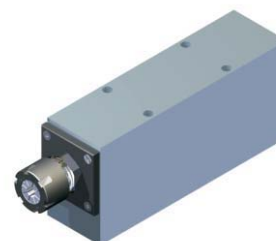

Radiale AM

ATO.DE20.1240

Pinza	ER-11
Rapporto	1:1
Velocità	8000 max
Trasmissione	puleggia
Lubrificazione	a vita

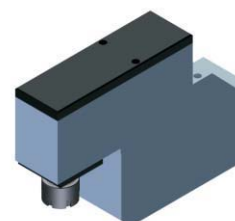



Linea TORNOS DECO20

Turbionatore ATO.DE20.0800

Attacco	testa per filettatura
Rapporto	1:1
Velocità	8000 max
Trasmissione	puleggia
Lubrificazione	a vita

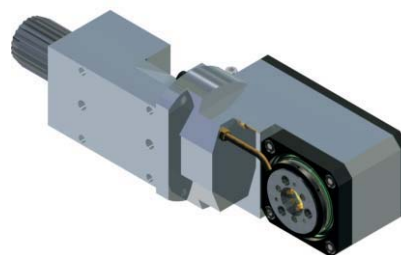

Turbionatore contro-operazione ATO.DE20.0810

Attacco	Testa per filettatura
Rapporto	1:1
Velocità	8000 max
Trasmissione	puleggia
Lubrificazione	a vita

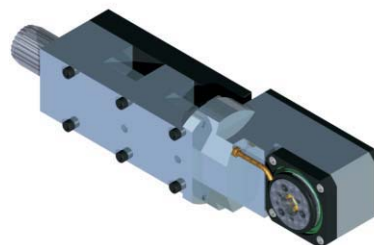

Poligonatore ATO.DE20.1000

Attacco	Fresa poligonatura
Rapporto	1:1
Velocità	8000 max
Trasmissione	puleggia
Lubrificazione	a vita

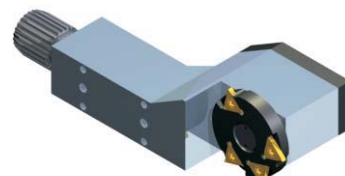

Exclusive dealer for Italy:

DAL LAGO TTC S.R.L.
Trade Tools Company

DAL LAGO TTC S.R.L.
Via Piave, 16 - 36077 Altavilla Vic.na (VI) - Italy
Tel +39 0444 349030 - Fax +39 0444 348964
www.dallago.it - info@dallago.it